

EUL-AP-LED

LED Elevated Approach Centerline Light

Compliance with Standards

CAAC:AC-137-CA-2015-01 & 03
 SAC: GB/T 7256
 ICAO: Annex 14, Volume I
 IEC: TS 61827
 FAA: AC 150/5345-46 & EB NO.67
 NATO: STANAG 3316

Application/Use

Approach centerline light

Features

- LED rated 70,000 hours, effective energy saving, maintenance-free, which brings enormous economic benefits to customer
- Excellent optical design to ensure full lighting spot when the glass is partially obscured
- Strict LED color management to ensure premium color consistency
- Consistent dimming curve with halogen lamp fixture, complying with FAA standards
- Proprietary driving circuit and thermal management solution, which greatly improves the reliability and service life of light fixture
- Power factor above 0.9, which minimizes the power network interference
- Optional function of single lamp failure detection, which enables the light to be open as halogen lamp once LED fails
- Compact structure and attractive appearance, with small windward area and strong wind resistance capability
- The main body is made of aluminum alloy with anti-corrosion surface treatment, all fasteners are made of stainless steel, suitable for various harsh environment applications
- High-precision parts and components machining to ensure all dimensional quality and accuracy
- Forged frangible device with precise machining, complying with FAA standards, ensuring good stability and reliability
- IP67-grade ingress protection of the fixture, keep interior from dust The fixture can be connected with one or two-inch extension pole, convenient installation, firmness and reliability
- The calibrator can be directly mounted to the body with convenient and precise installation and calibration
- Interchangeable, modular-designed components, applicable for all kinds of elevated unidirectional lights(LED type), which effectively cuts down the inventories.

Structure

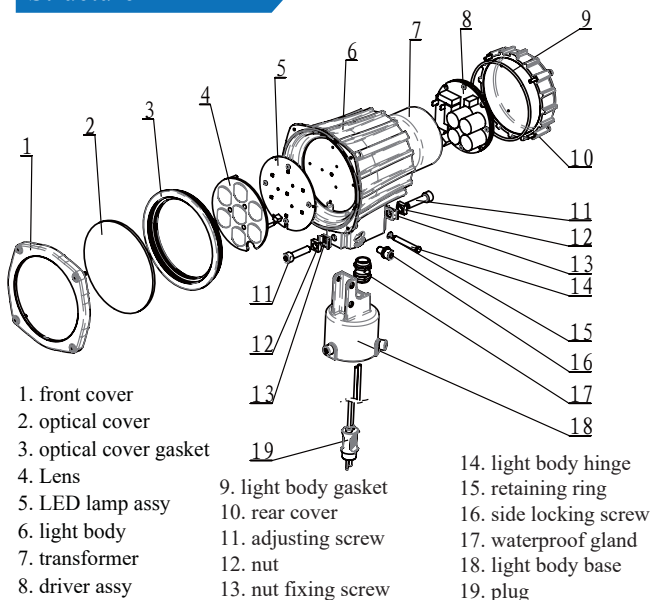

Ordering Information

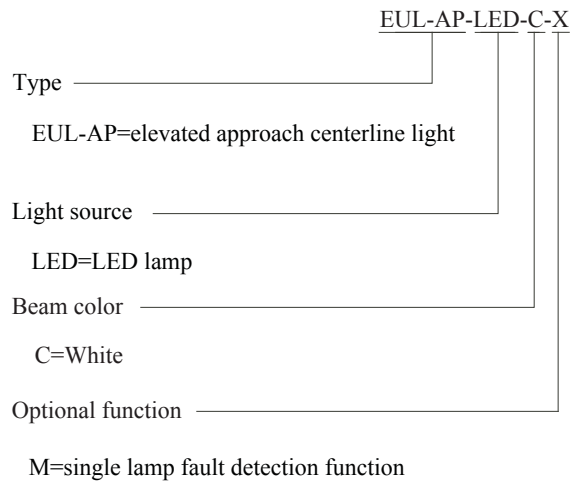

* Please provide detailed installation info while ordering, spare parts and accessories should be separately ordered with specific order no.

Installation

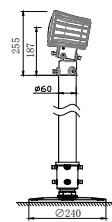

Fig 1. On extension pole.

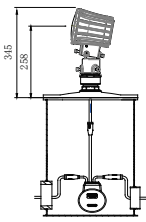

Fig 2. On 12" deep base.

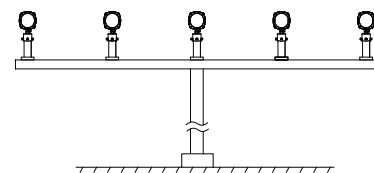
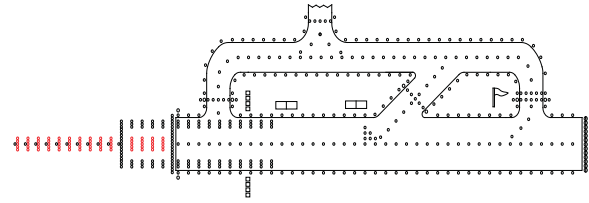

Fig 3. On approach mast.

* Please find detailed information in installation manual

■ EUL-AP-LED

■ LED Elevated Approach Centerline Light



Specifications

Light source: 7 white LED particles
 Power: 36VA
 Power factor: ≥ 0.9
 IP grade: IP67

Photometric Data

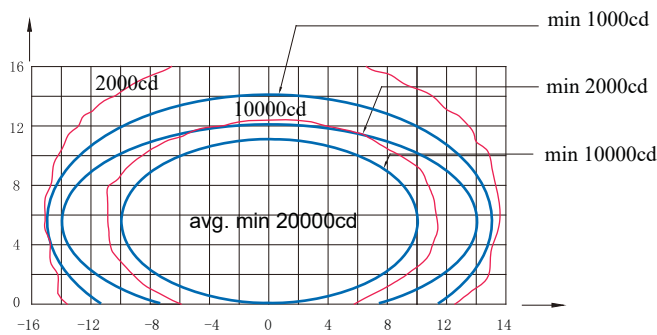

EUL-AP(White), ICAO Figure A2-1
 (Vertical main beam coverage 0°—11°)

Application		Main beam		Color	Required min avg. cd	Actual avg. cd
		H	V			
EUL-AP	ICAO Figure A2-1	$\pm 10^\circ$	0° — 11°	White	20000	22982
		$\pm 10^\circ$	0.5° — 11.5°	White	20000	23005
		$\pm 10^\circ$	1.5° — 12.5°	White	20000	22680
		$\pm 10^\circ$	2.5° — 13.5°	White	20000	23107

Packing Data

1 elevated light Size: 220×220×265 mm³
 Unit net weight: 3.5 kg Gross weight: 4.0 kg

Spare Parts

Struc No.	Part Name	Order No.	Description
2	Optical cover	31149	Front glass $\Phi 127$
3	Optical Cover Gasket	41110	Front cover sealing components rubber strip
5	LED Lamp Assy	979242-7-C	LED lamp 102 (7-0)White
6	Isolation Transformer	79126	Ring form isolation transformer (45W)
8	Lamp Body Gasket	41154	O-ring 102*3
17	Waterproof Gland	48401	Metal Waterproof Gland MG20×1.5
18	Plug	HT70603	Secondary Cable Connector-A6 Double core plug(Flat Type)-High Temperature resistance

Accessories

	Description	Order No.
1	Flange (10 inches)	FL-10
2	Flange (12 inches) G2 Screw	FL-12-X-G2
3	Frangible Coupling (2 inches)	FC-02
4	Isolation Transformer (45 W)	ITF-045-066
5	Secondary Calbe connector style 7	REC 7
6	leveling tool	954211
7	Isolation Transformer Box	TJB-12